



Swadro TC

CENTRE DELIVERY ROTARY RAKES

Swadro TC

Two-, four- and six-rotor rakes



KRONE Jet Effect

Protects the sward and produces clean forage without poking into the ground

Page 10

Pull-type and cardanic design

Optimum contouring and cleanest rakes

Page 11

KRONE DuraMax cam track

Perfect swath presentation and boosted harvest chain efficiency

Page 14

KRONE Easy-Line drive concept

Mechanical drives all-round for fast changeovers and high area outputs

Page 37

KRONE Lift Tines

These tines don't rake but lift the crop from the ground – delivering perfect results at low raw ash levels

Page 18

KRONE Swadro

– a machine you can depend on



KRONE centre delivery rotary rakes – the most comprehensive offer on the market

The KRONE Swadro TC line-up of rotary rakes offers the largest choice of centre delivery rakes in the market. Choose from an enormous variety of models and options – from the entry model, the Swadro TC 640 twin rotor rake as the best option for small and hilly fields, to the unique six-rotor unit, the Swadro 2000 that offers maximum efficiency and capacity.

#TEAM SWADRO



As a specialist manufacturer of hay and forage equipment, KRONE focuses on innovative and high-performance machines that make a difference in high-quality foraging. For years, the KRONE Swadro model range has set the benchmark in terms of quality rakes and clean forage.



As an innovation leader and specialist manufacturer of forage harvesting equipment, KRONE gives you the machine that fits into your individual harvest chain for uncompromised efficiency and forage quality.
Join the #TEAM SWADRO - BECAUSE YOUR ANIMALS DESERVE IT.

The pioneer in quality foraging

Every single blade of grass is clean



SWADRO creates an optimum swath that suits your individual harvester - whether baler, forage wagon or forage harvester.

It produces large and massive swaths that are ideal for the forager and boxy and uniform swaths for the cutting system on forage wagons and baler pick-ups for perfectly shaped bales.

KRONE Swadro lifts rather than rakes the material – maximizing your success at every single stage of your harvest campaign and sustainably for generations.

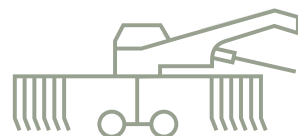

The world of Swadro TC models

How our KRONE Swadro transforms *into your personal KRONE Swadro for your requirements*

The KRONE Swadro TC programme of rotary rakes lines up the largest number centre delivery rakes on the market – from the Swadro TC 640 twin rotor rake and the new Swadro TC 1250 four-rotor rake to the world's largest centre delivery rake, the Swadro 2000, offering working widths from 5.70 m to 19.00 m. In addition to that, each model is available with multiple options and operator comfort features.



Swadro TC 640

Variable, 5.70 m to 6.40 m work widths



Swadro TC 680

6.80 m work width



Swadro TC 760 / 760 Plus

Variable, 6.80 m to 7.60 m work widths



Swadro TC 880 / 880 Plus

Variable, 7.60 m to 8.80 m work widths



Swadro TC 930 / 930 Plus

Variable, 8.10 m to 9.30 m work widths



Swadro TC 1000 / 1000 Plus

Variable, 8.90 m to 10.00 m work widths



Four-rotor centre delivery rakes
Swadro TC 1250
Variable, 9.80 m to 12.50 m work widths



Four-rotor centre delivery rakes
Swadro TC 1370
Variable, 10.80 m to 13.70 m work widths



Six-rotor centre delivery rake
Swadro 2000
Variable, 11.00 m to 19.00 m work widths

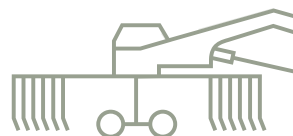

Powerful selling points

A successful harvest with *KRONE* rotary rakes

A successful harvest takes high-performance machines and powerful features.

KRONE DuraMax cam track

- Maintenance-free
- Dry cam track
- The steepest cam track in the market

Perfect and boxy swaths that maximize harvest chain efficiencies.

KRONE rotor gearboxes

- Maintenance-free
- Minimum input power
- Permanently lubricated

Maximum reliability and daily output from the first to the last swath.

Cardanic rotor suspension incl. KRONE Jet Effect

- Optimum ground contouring
- Minimum losses

Producing the best forage from the first to the last cut

SWADRO tine arms

- Maximum strength, stability and reliability
- Wear-free and gap-free folding arms
- Swift changeovers

Unmatched reliability and longevity from the first to the last job.

KRONE Lift Tines

- Clean forage from the Lift Effect
- High work rates without fragmentation

Raking up every single blade of grass





The KRONE Jet Effect

The KRONE Jet Effect ensures the tines will not dig into the ground when the rotors lower and lift. Emulating the touch-down and take-off behaviour of an airplane, The clever design of the rotor suspension ensures there is always a maximum of clear space between the tine and the sward when the rotor lifts and lowers out and into work – an intelligent system that helps protect the sward and avoids crop contamination.

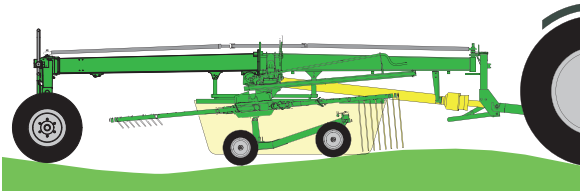

3D contouring

The rotors suspend in a pull-type and cardanic configuration which provides exact guidance to the tines and optimum contouring – both in and across the direction of travel. This way the tines pick up every haulm but not a single grain of sand. Uncontaminated forage, minimum loss rates and high work rates - this is the Swadro definition of quality work.



The pull-type and cardanic design

Producing the best forage *from the first to the last cut*

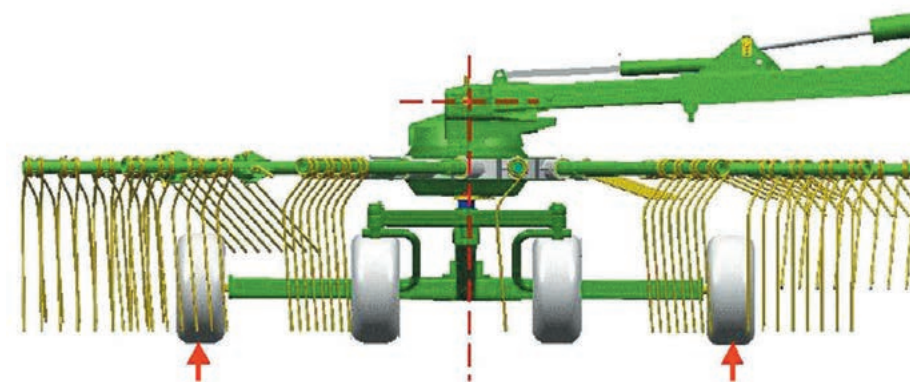

Pulling not pushing

The Swadro rotors are pulled in direction of travel. Its pull-type suspension in combination its central arrangement allows the rotor to stay level when lifting and lowering. Its weight is uniformly distributed to all gauge wheels, ensuring optimum contouring and minimizing contamination and losses.

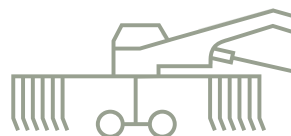

Top-quality forage

- **3D contouring** in any direction
- **Best possible 3D contouring** for all tines
- Clean forage, no losses

The Swadro rotor gearbox

Maximum reliability *from the first to the last swath*

Endurance design

- Sealed and **maintenance-free rotor gearboxes**
- **Fuel-efficient gear ratio**
- **Permanently fluid greased**



No downtime

The weather sets the pace in forage harvesting. Maintenance-free and permanently liquid greased rotor gearboxes make the KRONE Swadro a very reliable partner in your harvest campaign. Swadro is always ready to go, ensuring dependable operation in narrow harvest windows. No time is wasted on service stops. Come rain or harvester.





High performance meets minimum tractor input

The Swadro rotor gearbox is powerful and yet frugal in terms of tractor power. Thanks to its large gear ratio, Swadro requires only low pto speeds at minimum wear. Compared to other swathing systems, Swadro rotary rakes stand out for low input power and great fuel economy.



Rugged build

No matter how difficult the conditions, the Swadro rotor gearboxes deliver reliable performance and great stability without any servicing or maintenance. Count on these qualities.



The DuraMax cam track

Optimal and boxy swaths *that satiate high-capacity harvesters*



The unique DuraMax cam track

The KRONE cam track features the unique Bainite structure which is obtained by a special hardening process. Accordingly, this cam track has a very durable surface and yet a flexible core, a combination that results in low wear. This type of coating also reduces rolling resistance for reduced friction, wear and power input.



Steep and small-diameter cam track

Stand-out features of our **DuraMax cam track** is the extremely small diameter and steep track design. It is this unique design and its effect that lead to the formation of optimum swaths in all conditions. The small diameter of the cam track combines with the massive size of the rollers for smooth and low-wear operation. As the tine arms follow the steep curve the tines are promptly lifted out of work, forming boxy and optimum swaths in all conditions.

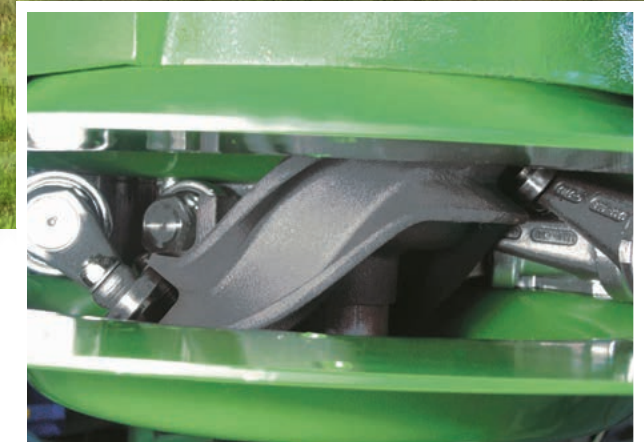



Forming optimal swaths

- Maintenance-free
- Special Bainite hardness
- Dry cam track

The Swadro tine arms

Dependable and durable *from dawn to dusk*

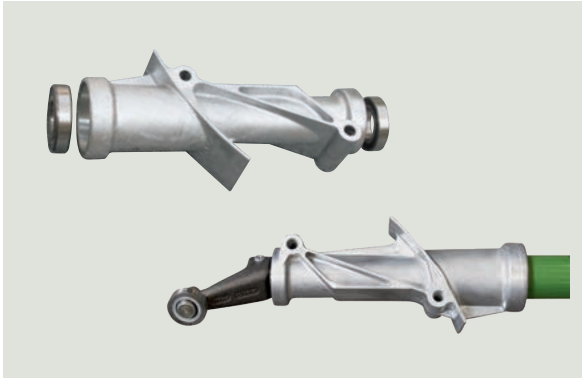

The tine arms

Each tine arm is controlled by its control shaft that is manufactured to precision-fit tolerances for exact fit in the control arm and precision tine control as the arm follows the cam track. It is this design that leads to those clean and loss-free rakes.

Each tine arm is mounted on two ball bearings inside the hub plate. The two bearings are spaced wide for stable and smooth control of the shaft as well as reduced wear and higher work rates.

The main part of the tine arm is the thick-walled and maintenance-free tube which is permanently and wear-free connected to the control shaft for reliable tine control without play. This is the secret behind optimum tine control and quality rakes.

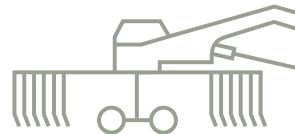



Changeover from transport to field is a matter of minutes

Some KRONE Swadro models have foldable tine arms either as a standard feature or an option for reduced transport heights.

This unique folding mechanism reduces the transport height and width in a matter of minutes without requiring the operator to remove the arms and carry them to their holder on the machine, reducing the strain on the operator and saving time and money when changing fields.

Belleville springs inside the arms connect the two parts reliably and fast, a solution that eliminates potential wear of a locking pin or hole. At the same time, the connection is gap-free and very durable to give reliable operation in many harvest seasons.

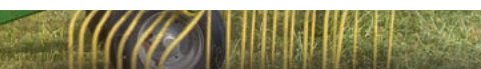

Operational reliability

- **Maximum stability** and reliability
- **Wear-free and gap-free** folding arms
- **Swift changeovers**
- **Pre-machined notch**

Maximum stability and reliability

The Swadro tine arms set the benchmark in terms of durability and reliable operation. The massive design of the arms with pre-machined notches makes these arms stand out in the rotary rake sector, because it withstands the highest loads and brings peace of mind in extremely difficult conditions.

The KRONE Lift Tine

Exceptional rakes. *Not a single grass blade is left behind*

Effective in every respect

- **Clean forage** thanks to the Lift Effect
- **High work rates** and no fragmentation
- **Improved forage quality**
- **Reduced losses**

All current KRONE Swadro models have the KRONE Lift Tines as standard specification. Kinked in two positions, these tines offer significant benefits that have been verified in KRONE field tests and a DLG Focus Test.

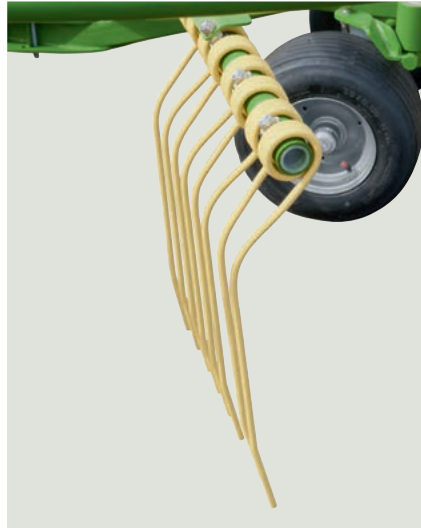

The double kink trick

For more than 10 years, the KRONE Lift Tine has convinced our customers around the world in terms of quality forage and rakes. Kinked in two positions, the vertical tine lifts the material clear off the ground. This is the secret behind producing clean forage in difficult conditions.

The Lift Effect sees the grass moving up the length of the tine. Even extremely wet and heavy material will not bend the tines which are up to 10.5mm thick and are coiled around large-diameter arms for greatest stability and tidiest rakes.



How KRONE Lift Tines boost your yields

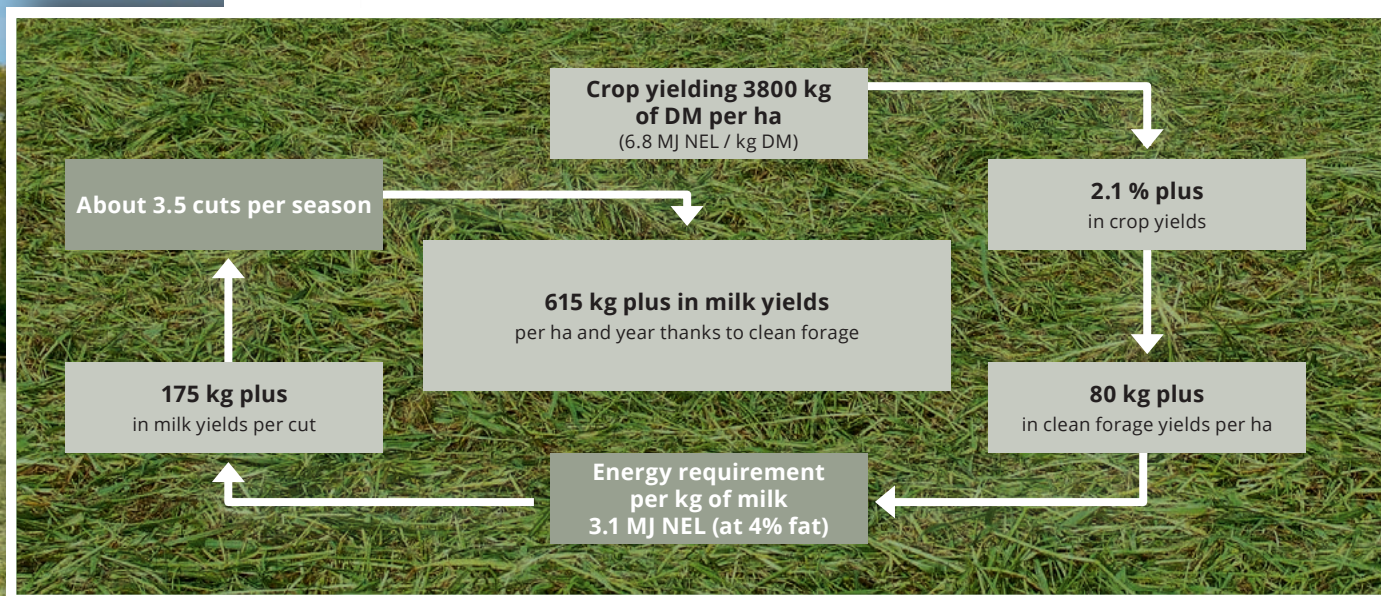

DLG confirms: Less contamination and fewer losses in the raking pass

- We place greatest importance on clean forage and an excellent raking quality. Therefore, we seek scientific evidence in confirmation to our visual assessments.
- Consequently, we submitted the Krone Lift Tines to a DLG Focus Test in order to assess the level of crop contamination and rake quality and compare the results with other tine systems.
- The results were indeed very clear: The Krone Lift Tines reduce crop contamination with raw ash to levels of less than 9% - at any forward speed.
- In addition, the special design of the tine reduces losses by up to 2.1% compared with other systems. Losses never reach 1.5% of the total crop yield, not even at high work rates



The bogies on the KRONE Swadro rakes

Perfect contouring and clean rakes *in any terrain*



Excellent rides

The guide wheels on the bogies run very close to the tines for effective guidance and contouring. As the wheels cover a large surface area, the tines pick up every single blade without contacting the sward.

In addition, every model has individual setting options that help adjust the bogies to the specific conditions. The leading wheels are castering.

High flotation tyres are options for soft and boggy terrain and two extra wheels are available for each rotor for work in very rough pastures.

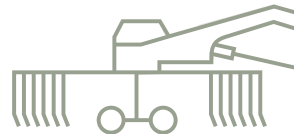

Lifting and swathing

- Gauge wheels on **high flotation tyres** run very close to the tines
- **The largest wheelbase** on the market
- Adjuster changes the rotor angle across the direction of travel for **optimum swaths and loss-free rakes**.
- **Caster steer wheels** at front and rear (option) protect the sward

The wheels under the KRONE Swadro rotors never lose contact with the ground, not even the roughest terrain. The largest possible contact area and pivoting range in combination with suitable tyres ensures no blade is left on the sward and the sward is not damaged. Clean and intact swards are the cornerstone for top quality forage also from the next cut.



Slightly tilted for greatest efficiency

An optimum rotor tilt across the direction of travel translates into minimal losses and boxy swaths. All Swadro rotors tilt as a standard feature. The lateral tilt controls the position of the tines relative to the ground and is set on the rear wheels of each rotor. In fact, the rotor should tilt slightly towards the swath in order to balance out the load the material puts on the tines. KRONE recommends a 1-2 cm tilt toward the swath.



The twin-rotor centre delivery rakes

Swadro TC and Swadro TC Plus



The manual height control system

All Swadro TC rotors have their work height adjusted down to the millimetre. This is done on a crank which is arranged on the outside of the rotor for easy access. A large scale helps operators to read the current position.



The electric height control system

Those who often use the rake in varying conditions will find it helpful to opt for the electric rotor height control system. This is standard specification on all Swadro TC Plus models. From the cab-based control box, operators control two servomotors which change the rotor height conveniently and accurately. This control box also displays the current working height and raises the rotors individually.

Adjust the work width to the job at hand

- **Flexible working widths.** Maximum throughputs on forage wagons, balers and foragers
- **High rotor lift-out** on the headland. No disturbance of voluminous swaths
- **Maximum operator comfort.** Relaxed work on long working days

KRONE Swadro TC and TC Plus rotary rakes offer compelling selling points: uniform swaths, high work rates, clean rakes and multiple pre-sets to suit every singly condition. More than that, the Swadro TC Plus features maximum operator comfort for fatigue-free work on long working days.



The mechanical width control

Swadro TC 640 and TC 760 come with a standard mechanical working width control. The arms are extended and retracted to the required work/swath width by operating a crank.



The hydraulic width control

All Swadro models from TC 880 onwards are adjusted hydraulically to the proper work width (option on TC 640 / TC 760). This is done from the convenience of the cab and assisted by a clear scale on the arm.



Individual rotor lift-out

The rotors can be lifted out independently. This is standard specification on the TC 930 and TC 1000 and an option on all other Swadro TC models. This feature brings great advantages in wedges and along boundaries.



The rotor suspension system

Strong coil springs transfer some of the weight to the main beam and the chassis as the rake is swathing along – for light treading on soft soils and clean rakes in any situation.



Swadro TC and TC Plus

Special features translate into an *exceptional harvest success*



Swadro TC 1000 / TC 1000 Plus

The two top rakes in our twin-rotor centre delivery programme offer work widths of up to 10.00 m to satiate high-capacity foragers and forage wagons. One speciality of the TC 1000 is the coil spring suspension system, the independent rotor lift-out feature and the six-wheel running gears, all of which are standard features. The TC 1000 Plus has an eight-wheel running gear. A six-wheel and eight-wheel running gear provides reliable guidance to the 4.20 m diameter rotor and optimum tine contouring. The combination of this type of running gear and suspension system translates into thorough rakes and clean forage even on the high-capacity TC 1000 / TC 1000 Plus models.



Swadro TC 680

The Swadro TC 680 has a fixed 6.80 m work width, which makes it the ideal rake to work ahead of a compact round baler or forage wagon, producing swath widths that suit a narrower pick-up on a smaller harvester for optimum efficiency and cutting quality.





The unique disturbing rotor

KRONE is the only manufacturer who markets twin-rotor centre delivery rakes which can rake all the material. To disturb and aerate dry and light material, Swadro TC 680 and 760 can be equipped with a KRONE development – the disturbing rotor. Positioned in the middle of the rake and carrying six tines, the hydraulic rotor disturbs and aerates all the material in the middle of the machine between the left and right rotors. This promotes uniform wilting and boosts the quality of hay and leafy forage such as lucerne.

Swadro TC and TC Plus

Easy steering and safe road travel



Generous ground clearance

The high-clearance frame and the high rotor lift-out allow the machine to run over massive windrows without disturbing them.



Exceptional and patented manoeuvrability

Swadro TC and TC Plus are attached to the two-point headstock by a ball bearing joint and a rod-steered undercarriage with articulated steering. This patented combination makes this KRONE rake a particularly nimble machine – a boon in awkward areas where no crop is left behind and shunting is eliminated. The machine simply goes into every corner of the field without manoeuvring. The articulated steering is an option on the TC 640.

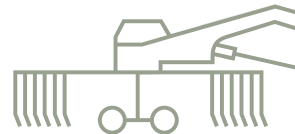



Choice of tyres

The chassis of the Swadro TC rakes have standard 10.0/75-15.3 tyres and the ones on TC 880, 930 and 1000 run on 11.5/80-15.3/10 PR tyres (left photo). All models from Swadro TC 680 can be fitted with 15.0/55-17/10 PR (right photo) tyres that suit softer soils or sloping fields. Both models offer a transport width of less than 3.00 m and the TC 640 can be clad with special AS tyres.



Adjusting the track width

If the wheels are fitted with slim tyres, it will be possible to expand the track width by 6 cm (2.4"). Simply refit a distancer sleeve on the wheel arms and move each axle out 3 cm (1.2").

Swift and safe travel

Great road stability and exceptional casting are the stand-out features of the chassis that is approved to 40 km/h (25 mph).

Reduced transport height

Quick changeovers bring down the transport height to less than 4 m (13'2"), fold up the rotors without removing any tine arms (except TC 1000) or guards and retract the telescoping arms to reduce the machine width.

For us, it is important to get a wide spread from the leading rotors, because this eliminates roping.



Raking made easy and tidy

The KRONE Easy-Line increases rotor rpm on the leading units by about 25% compared with the rear units, so the leading rotors present the material in a wider mat to the ones at the rear which rake it into fluffy and boxy swaths. The Easy Line driveline ensures the material doesn't drop back on the ground once it has been picked up. This explains why even the multiple-rotor rakes in the KRONE Swadro range ensure gentle treatment and minimal contamination even when several rotors work in sequence.

KRONE Easy-Line drive concept

More rpm *on four-rotor and six-rotor rakes*



The patented power package

The KRONE Swadro four-rotor rakes have purely mechanical drivelines where every rotor is individually protected from overload for maximum protection from total machine failure. The drive power flows efficiently from the patented crash box on the leading rotors to the rear rotors. The straight driveline not only reduces the strain on the universal joints but also improves fuel economy.

The efficient way of swathing

- **A controlled material flow** through the machine for best rakes
- **Boosted outputs** from the forage wagon, baler or forager
- **No roping** for maximum harvester performance

Enter the world of high-output rakes

Swadro TC 1250 - *the small model in the top league*



Flexible width

The working width and also the swath width are adjusted hydraulically as a standard feature for fast adaptation to varying conditions. The arms telescope rapidly to the correct working width – wide when gathering the last cut for presentation to the forager or narrow for the forage wagon and round baler.

Extremely manoeuvrable and convenient

The TC 1250 with two-point headstock pivots in the lower links for smooth and stable rides on roads and in the field. Turning through a large angle, the headstock makes for tight headland turns and effective rakes in corners, a feature that saves valuable time in narrow harvest windows.

Intriguing entry models

- Entry-level four-rotor rake with **variable 9.80 m to 12.50 m widths**
- **KRONE Easy-Line drive system** for a perfect swath presentation to the baler, forage wagon and forager
- **Straightforward and fast** height control with a useful scale
- **Fast changeovers** to less than a 4 m transport height from the cab
- Exact and infinitely variable **hydro suspension** for optimum contouring
- **Individual rotor lift-out is an option** and ideal in corners

The new Swadro TC 1250 marks KRONE's entrance to the high-capacity rake sector. The machine combines heavy-duty components from professional machines with the simplicity of twin rotor rakes, making the TC 1250 the ideal all-rounder for large farming operations, machinery rings and contractors.



Exact working heights

The operator sets the height of each individual rotor manually on the crank and reads the current height on the large scale.



Strong frame

Swadro TC 1250 features a modern and appealing styling with a trapezium frame and massive tube steel arms that ensure high stability and longevity. The sloping panels keep the machine clean and country roads, too.

Swadro TC 1250

Convenient operation *from a base specification tractor*



Swift and easy transport

Compact by design, less than 3 m wide and less than 4 m high without folding the tines, this rake makes for convenient and safe travel between fields.



The right tyres for each job

The transport wheels are clad with 500/50-17 tyres as a standard. Wider 620/40 R 22.5 flotation tyres are available as an option, offering a larger contact area for gentle treading and minimum compaction in softer soils.



Springs at front and rear

In work, strong coil springs shift the weight of the rear rotors to the main beam and the chassis, thereby taking load off the rear rotors. By comparison, the front rotors have hydraulic suspension which is set steplessly on the on-board spool chest by switching from lift-out to suspension and vice versa, allowing the machine to adapt easily and conveniently to any terrain – for cleanest swaths and best forage quality.





Finger-tip control

The TC 1250 is entirely operated from the KRONE control box. Functions like individual rotor-lift out, swath width control or telescoping front arms are selected on the control box and executed by the tractor spools. Thanks to this selector box, the machine requires only one single-acting and one double-acting tractor spool. This gives you maximum operator comfort from an entry-level tractor.



Premium ride comfort

The front and rear rotors are lifted out via sequence control. The shift gate on the front arm allows operators to alter the timings in line with the current forward speed and their needs. Highest acreages and yet maximum operator comfort.

The leading rotors can also be raised individually as an option. In this specification, the operator pre-selects a rotor and then raises it by operating the tractor spool. After that, the sequence control system raises the opposite rotor and the rear units. Perfect rakes in the most awkward shaped fields.

Another option allows operators to raise/lower the leading and rear rotors in pairs – either sequence controlled or in front/rear pairs.

The pro among the four-rotor rakes

Swadro TC 1370 – *the flexible machine in the top league*



Variable work width

Telescoping hydraulic arms adjust the positions of the two leading rotors left and right separately. This way, the rake can vary its working width from 10.80 m to 13.70 m to adapt to varying field conditions. The rotors resume their previous positions automatically when lowering into work.



Flexible swathing width

The swath width is adjusted irrespective of the work width by varying the distance between the two rear rotors between 1.40 m and 2.20 m. As another key feature, the tine arms on the rear rotors have five double tines which optimize the work and quality for the following harvester.



Hydraulic suspension

The hydraulic rotor suspension that is integrated in the lifting cylinders provides gentle treading also in difficult conditions. The system is set up steplessly and conveniently from the tractor and separately for the leading and rear rotors.

The new and integral Soft-Down drop rate control lowers the rotors particularly softly into work – a boon for the quality of feed.

Professional equipment

- **Variable work widths** – 10.80 m to 13.70 m
- **Hydraulic rotor suspension**
- **Integral vibration damper** with Soft-Down drop rate control
- **Electric rotor height control** with two selectable height options
- **Flotation tyres** – 710 tyres on the transport running gear and 16x9.50 tyres on the bogies
- Hydraulic beam control for **less than 4.00 m transport heights**
- **KRONE Easy-Line driveline** for optimum swaths and rakes

The Swadro TC 1370 four-rotor centre delivery rake makes its appearance in a modern styling and with plenty of landmark features including convenient setting options that make the job a lot easier for operators and produce optimum swaths at high outputs.

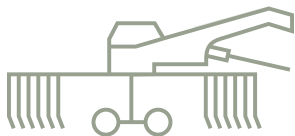



Setting the rotor height

The operator controls the work height from the terminal so there is no need to dismount the tractor. You can either adjust all rotors at the same time or each rotor separately. Also, you can program two different heights to the system and retrieve them later by fingertip control.



Choice of tyre options

620/40 R 22.5 transport tyres are standard specification. But you can also opt for hydraulic brakes and wider 710/35 R 22.5 tyres to improve the performance in boggy terrain. Both tyre sizes are small enough to ensure that the 40 km/h machine doesn't exceed the statutory 3 m transport width.



Uncompromised contouring

The rakes that run on standard transport wheels have caster-steer bogies with pivoting wheels that are clad with 16x6.50-8 tyres. The rake can also take the wider 16x9.50-8 tyres on the bogies provided the tyres on the transport running gear are the optional 710/35 R 22.5 size. Both tyre sizes are also available for 6-wheel bogies with rear tandem axle.



Swadro TC 1370

Unmatched flexibility and operator comfort



Easy-going headland turns

You can set and retrieve separate lift-out heights for the leading and rear rotors from the tractor terminal. More than that, you can set the lift-out height and also time the front and rear lift-out according to the prevailing conditions, making the most of narrow harvest windows.

Convenient changeovers

The beam lowers hydraulically to a transport height of less than 4 m, meaning you don't have to fold or remove any tine arms.

Tractor attachment to suit

The TC 1370 is attached to the tractor via the pivoting two-point headstock which allows the machine to follow tractor roll for agile manoeuvring. But you can also opt for a bottom-mount 80 ball hitch.

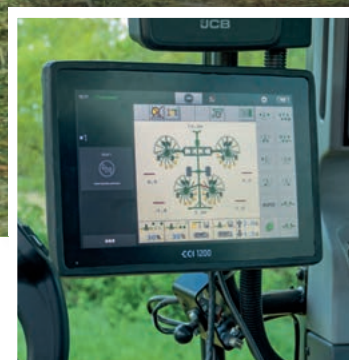

Easy-use terminal

The TC 1370 offers clear and comfortable navigation. No matter which terminal you opt for – your existing ISOBUS tractor terminal, the ISOBUS-compatible CCI 800 or CCI 1200 terminal or the KRONE DS 500 unit – each option offers user-friendly machine setups at just two menu levels.

Intuitive use

The DS 100 is an entry-level control unit for the TC 1370. Provided a UT terminal is in place, this unit can also be conveniently mounted on the armrest. But the TC 1370 can also be operated from the ISOBUS-compatible WTK joystick or the CCI A3 joystick for convenient and fatigue-free work.



Automatic Section Control

The SectionControl feature lifts and lowers the individual rotors separately to avoid multiple rakes in awkward patches. The feature reduces operator stress and boosts productivity thanks to faster headland turns.



Unique in six ways

Swadro 2000 – *leaving competitors way behind*



The width is right in all conditions

The rake can vary its work width between 10.00 m and 19.00 m hydraulically, producing swaths that match the capacities of the following harvesters. To do that, the two arms extend and retract on a sliding carriage so the two rotors in the pair will always rake up the same amount of material, producing uniform and consistent swaths that suit exactly the capacity of the following harvester.



Each pick-up is served the right swath

Not only is it possible to adjust the working widths to needs but also to adapt the swath width. This is done by adjusting the rear rotors hydraulically and steplessly between 1.60 m and 2.80 m which is preset on the terminal. The technology helps form perfectly boxy and high-volume swaths for round balers and forage wagons.

There's nothing quite like it in the world

- **Variable work widths** from 10.00 m to 19.00 m (62'4")
- **Stepless swath width control** from 1.80 m to 3.00 m
- **Automatic rotor overlap control**
- **Intelligent** transport chassis steering

The Swadro 2000 sets the benchmark in terms of area output and quality rakes. Offering flexible work widths from 10.00 m to 19.00 m, the machine clears up to 20 ha/h. This enormous work width reduces swath lengths by up to 30%, reducing field traffic in the following harvest chain. In addition to that, Swadro 2000 boosts the performance of the following harvesters by up to 15%. This is particularly efficient in low-yielding stands where more width is grouped into a single swath to satiate the enormous appetite of the forager or forage wagon.



Swadro 2000

Maximum work widths and *operator comfort*

The automatic folding feature

A hydraulic sequence control manages the individual steps, taking off stress and strain from the operator.

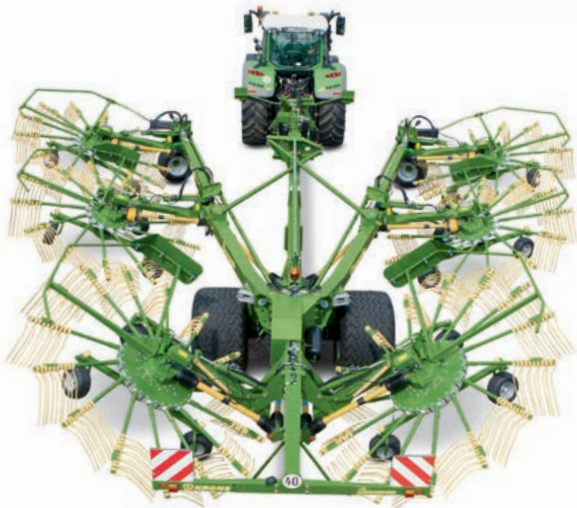
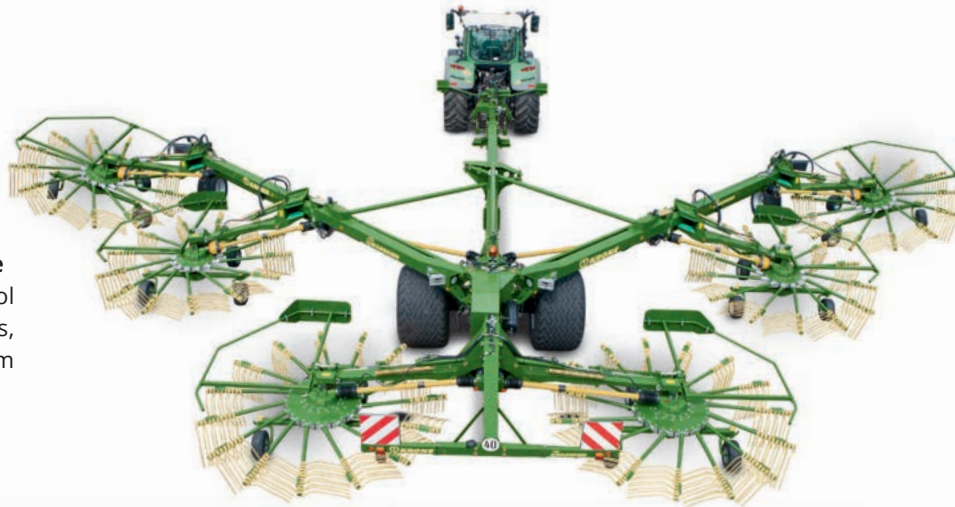

Conveniently operated

- **Maximum operator comfort, easiest set-ups** from the cab
- **Time sequence controlled** lift and lower
- **Folding on a touch of button**

The time sequence control times the lifting and lowering of the rotors, making sure the enormous potential of the Swadro 2000 is exploited to the full. In tandem with automatic section control, the feature allows the machine to rake up awkward patches and corners in no time. Machine setup and operation are equally convenient and straightforward from the terminal.



The DS 500 Terminal

The compact DS 500 terminal has a 5.7-inch colour display screen and is operated either from the touchscreen or twelve functions as preferred. An optional ISOBUS joystick is available for even more operator convenience and reduced strain on long working days.



The CCI 800 terminal

The CCI 800 is an ISOBUS-compatible touchscreen terminal with 8-inch colour display screen which shows either the main view or up to two additional views. For example, you can switch between the joystick control view, Section Control view and a camera view on the move.



SectionControl

The automatic SectionControl feature is very useful when raking out wedges and awkward patches. Detecting raked areas and raising the rotors, this feature prevents the same patch is raked twice. The feature puts operators at ease and makes sure Swadro 2000 is operated to capacity on long working days.



Swadro 2000

Intelligent running gear *for maximum manoeuvrability*



The unsteered axle

The axle on the transport chassis is switched off during work. This feature ensures uniform and straight swaths that keep the following harvester happy.



The passive-steer axle

The steered axle is activated automatically when the rotors are being lifted out of work. At this moment the chassis is steered via a rod – a detail that ensures maximum agility in headland turns and cuts turn-around times.



The active-steer axle

The extra cylinder on the steering linkage helps manage narrow field and farm gates and clear awkward patches. Even the narrowest field gates are entered without shunting.

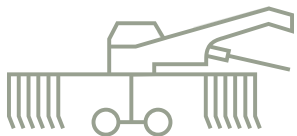



Surprisingly nimble

- Caster steer axles on the **transport running gear**
- Automatic **steering control** in fields and on headlands
- **Manual steering override feature**



A robust linkage attachment

Swadro 2000 hitches to the tractor link arms and has a pivoting cat II/III headstock that compensates for any humps and bumps. The sturdy stand provides uncompromised stability.



The beefy transport chassis

Running on big 800/45 R 26.5 tyres for good road stability, the transport chassis is approved for road travel at 40 km/h and is gentle on the ground and sward.



Flexible Ackermann steering

The Ackerman steering system on the transport chassis can be operated in two ways: either passively via a linkage or actively via a hydraulic ram. Excellent casting, manoeuvring in tightest space and easy steering are the qualities that make this chassis stand out from everything else.



An extra hydraulic steering system

The extra hydraulic steering system will be appreciated by those who seek tighter turns to manage narrow gates and by those who do a lot of countersteering in sloping fields. A hydraulic cylinder on the steering linkage adjusts the turn angle or ride behind the tractor.





Technical data

KRONE twin-rotor centre delivery rakes



	Swadro TC 640	Swadro TC 680	Swadro TC 760	Swadro TC 880	Swadro TC 930	Swadro TC 1000
Dimensions						
Mechanical work width control	Standard	-	Standard	-	-	-
Hydraulic work width control	Option	-	Option	Standard	Standard	Standard
Swath width	approx. 1.00 - 1.70 m (3'3" - 5'7")	approx. 1.00 m (3'3")	approx. 1.00 - 1.80 m (3'3" - 5'11")	approx. 1.30 - 2.50 m (4'3" - 8'2")	approx. 1.30 - 2.50 m (4'3" - 8'2")	approx. 1.30 - 2.50 m (4'3" - 8'2")
Transport width with standard tyres	approx. 2.54 m (8'4")	approx. 2.72 m (8'11")	approx. 2.72 m (8'11")	approx. 2.86 m (9'5")	approx. 2.84 m (9'4")	approx. 2.84 m (9'4")
Transport width with optional tyres	approx. 2.70 m (8'10")	approx. 2.89 m (9'6")	approx. 2.89 m (9'6")	approx. 2.99 m (9'10")	approx. 2.99 m (9'10")	approx. 2.99 m (9'10")
Transport height (rigid tine arms or foldable arms extended)	3.55 - 3.90 m (11'8" - 12'10")	3.99 m (13'1")	3.99 - 4.39 m (13'1" - 14'5")	3.99 m (13'1")	3.99 m (13'1")	3.99 m (13'1")
Transport height (arms folded in)	2.90 - 3.40 m (9'6" - 11'2")	3.55 m (11'8")	3.57 - 3.97 m (11'9" - 13'0")	3.55 m (11'8")	3.55 m (11'8")	3.75 m (12'4")
Storage length	4.82 m / 5.39 m (15'10" / 17'8")	5.90 m (19'4")	5.90 m (19'4")	6.33 m (20'9")	6.75 m (22'2")	6.75 m (22'2")
Weight						
in standard specification	approx. 1,400 kg (3086 lbs)	approx. 1,700 kg (3748 lbs)	approx. 1,950 kg (4299 lbs)	approx. 2,300 kg (5071 lbs)	approx. 2,780 kg (6129 lbs)	approx. 3,000 kg (6614 lbs)
Tractor power	approx. 22/35 kW/hp	approx. 37/50 kW/hp	approx. 37/50 kW/hp	approx. 40/55 kW/hp	approx. 51/70 kW/hp	approx. 51/70 kW/hp
Area output	approx. 5.5 - 6 ha/h	approx. 6.5 - 7 ha/h	approx. 7.5 ha/h	approx. 8 - 8.5 ha/h	approx. 9 - 9.5 ha/h	approx. 9.5 - 10 ha/h
Rotors						
Number	2	2	2	2	2	2
Rotor diameter	2.70 m (8'10")	3.30 m (10'10")	3.30 m (10'10")	3.60 m (11'10")	3.80 m (12'6")	4.20 m (13'9")
No. of tine arms per rotor	2 x 10	2 x 10	2 x 13	2 x 13	2 x 15	2 x 15
Rigid arms	Standard	Standard	Standard	Standard	Standard	-
Foldable arms	Option	Option	Option	Option	Option	Standard
No. of double Lift Tines per tine arm	3 (optional 4)	4	4	4	4	4
Tine thickness	10.5 mm (0'4")	10.5 mm (0'4")	10.5 mm (0'4")	10.5 mm (0'4")	10.5 mm (0'4")	10.5 mm (0'4")
Tyres on bogies	16x6.50-8 standard	16x6.50-8 standard	16x6.50-8 standard	16x6.50-8 standard	16x6.50-8 standard	16x6.50-8 standard
	-	-	18x8.50-8 option	18x8.50-8 option	18x8.50-8 option	18x8.50-8 option
Mechanical height control c/w scale	Standard	Standard	Standard	Standard	Standard	Standard
Electric height control c/w scale	-	-	Option	Option	Option	Option
Spring suspension	Option	Option	Option	Option	Standard	Standard
Separate rotor lift/lower feature	-	Option	Option	Option	Standard	Standard
Transport chassis						
Standard tyres	10.0/75-15.3 8 PR	10.0/75-15.3 8 PR	10.0/75-15.3 8 PR	11.5/80-15.3 10 PR	11.5/80-15.3	11.5/80-15.3
Optional tyres	15.0/55-17 AS	15.0/55-17 10 PR	15.0/55-17 10 PR	15.0/55-17 10 PR	15.0/55-17 10 PR	15.0/55-17 10 PR
Link arm attachment	Standard	Standard	Standard	Standard	Standard	Standard

All specifications, weights and dimensions do not necessarily comply with standard specifications and are therefore not binding. All product specifications are subject to change.



Technical data

KRONE four- and six-rotor centre delivery rakes



Side delivery rakes

		Swadro TC 1250	Swadro TC 1370	Swadro 2000
Dimensions	Work width	9.80 - 12.50 m (32'2" - 41'0")	10.80 - 13.70 m (35'5" - 44'11")	10.00 - 19.00 m (32'10" - 62'4")
	Work width control	Hydraulic	Hydraulic	Hydraulic
	Swath width control	Hydraulic	Hydraulic	Hydraulic
	Swath width	approx. 1.40 - 2.20 m (4'7" - 7'3")	approx. 1.40 - 2.60 m (4'7" - 8'6")	approx. 1.60 m - 2.80 m (5'3" - 9'2")
	Transport width with standard tyres	approx. 2.99 m (9'10")	approx. 2.99 m (9'10")	approx. 2.99 m (9'10")
	Transport height (rigid tine arms)	3.99 m (13'1")	3.99 m (13'1")	3.99 m (13'1")
	Storage length	8.28 m (27'2")	9.10 m (29'10")	13.20 m (43'4")
Weight	in standard specification	approx. 4,850 kg (10692 lbs)	approx. 5,800 kg (12787 lbs)	approx. 9,400 kg (20723 lbs)
Tractor power		approx. 59/80 kW/hp	approx. 59/80 kW/hp	approx. 96/130 kW/hp
Area output		approx. 10 - 13 ha/h	approx. 13 - 16 ha/h	approx. 10 - 20 ha/h
Rotors	Number	4	4	6
	Rotor diameter	3.30 m / 2.96 m (10'10" / 9'9")	3.60 m / 3.30 m (11'10" / 10'10")	2 x 3.30 m / 3.38 m (2 x 10'10" / 11'1")
	No. of tine arms per rotor	2 x 11 / 2 x 13	4 x 13	4 x 13 / 2 x 15
	Rigid arms	Standard	Standard	Standard
	No. of double Lift Tines per tine arm front/middle/rear	4 / - / 4	4 / - / 5	4 / 4 / 5
	Tine thickness	10.5 mm	10.5 mm	10.5 mm
	Tyres on bogies	16x6.50-8 standard	16x6.50-8 standard	16x6.50-8 standard
		-	16x9.50-8 option*	-
	Mechanical height control c/w scale	Standard	-	-
	Electric height control c/w scale	-	Standard	Standard
	Rotor suspension	mechanical / hydraulic	hydraulic	mechanical
Separate rotor lift/lower feature	Option	Standard	Standard	
Transport chassis	Tyres	500/50-17 standard	620/40 R22.5 standard	800/45 R 26.5 standard
		620/40 R 22.5 option	710/35 R22.5 option	-
	Link arm attachment	Standard	Standard	Standard
	Ball hitch	-	Option	-
AEF-certified for		-	UT, AUX-N, TC-BAS, TC-SC	UT
Ready for KRONE Smart Telematics		KSC Solar option	KSC 500 option	KSC 500 option

All specifications, weights and dimensions do not necessarily comply with standard specifications and are therefore not binding. All product specifications are subject to change.

* if transport wheels are fitted with optional 710/35 R 22.5 tyres

Maschinenfabrik Bernard KRONE

We connect tradition and vision.



Your local KRONE dealer



Maschinenfabrik Bernard KRONE GmbH & Co. KG

Heinrich-Krone-Straße 10

D-48480 Spelle

Phone: +49 (0) 5977 935-0

info.ldm@krone.de | www.krone.de